

**SONY**  
make.believe

# Home Theater Projector

**VPL-HW55ES**



# Get Closer to a Real Cinema Experience

The VPL-HW55ES is a Full HD 3D home theater projector packed with our latest technology for a incredibly sharp, crystal clear cinematic experience.

Enhanced light efficiency and an optimised optical block, enables the VPL-HW55ES projector to reach 1,700 ANSI lumen brightness, delivering clearer images in well-lit environments. The VPL-HW55ES also has an approximately 5,000 hour long-lasting lamp due to its improved lamp cooling system. An optical engine upgrade, contrast enhancer technology and Advanced Iris3 technology enable a dynamic contrast ratio of more than 120,000:1. This increases black and white levels without diminishing peak brightness to maximise detail during darker scenes. Additional features such as Sony's Bright Cinema and Bright TV mode, with SXRD panels, enhances the 3D image even further. The projector also has Sony's Reality Creation technology.

## Well-balanced, High-brightness, High-grade Images

Thanks to an improved optical engine, the VPL-HW55ES is much brighter than our previous standard home theater projectors. At 1,700 lumens, it produces clearer images and faithful colors, even in well-lit rooms.

Standard home theater projector



VPL-HW55ES



Simulated images

## Reality Creation for Full HD

Developed for the Sony 4K home theater projector, this function has now been adapted for the new VPL-HW55ES projector. It reproduces the texture and color of the original 1080p signal by restoring missing information lost during packaging of the original contents to disk and broadcast transmission. As a result, you can enjoy sharp and crisp full HD pictures.

Input signal

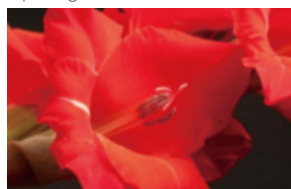

View the best possible images

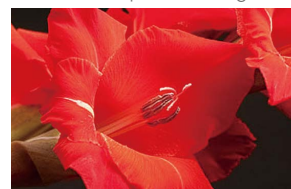

Reality Creation restores missing information

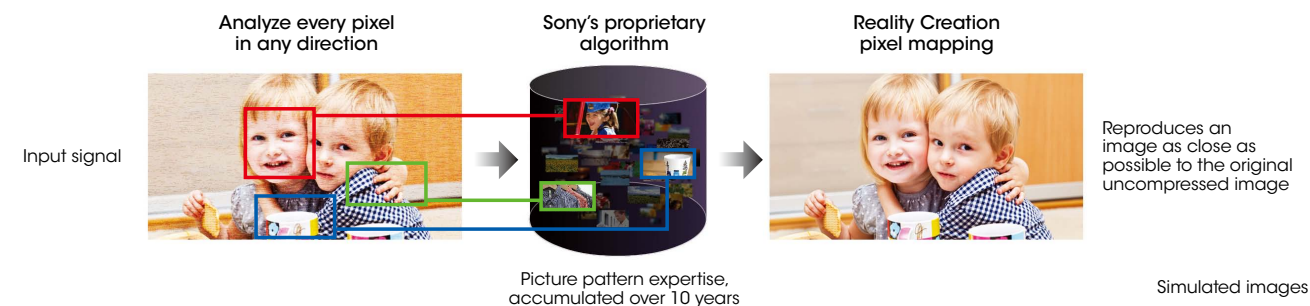

## Dynamic Image with High Contrast

### Advanced Iris 3

This is an automatic Iris control feature that enhances the contrast in accordance with the scene. It maximizes black and white levels without diminishing peak brightness. Thanks to improved Advanced Iris3 algorithm, the projector has a dynamic contrast ratio of 120,000:1.

### Contrast Enhancer







This function automatically adjusts the contrast for optimum viewing. It compensates for dark and bright parts of an image by analysing the signal component of each scene in real time to enhance contrast.

## Bright Cinema and Bright TV Picture Modes

Conventional home theater projectors typically enhance the green color to secure image brightness. However, the VPL-HW55ES boasts the new Bright Cinema and Bright TV Mode. With optical block and signal processing improvements bringing high brightness without a loss in color reproduction and contrast, you can enjoy bright, crisp images even when viewing in a well-lit room.

## Powerful Picture Calibration Features

There are eight calibrated presets to optimize various content.

<b>Cinema Film 1</b> Highly dynamic and clear images of typical master positive film		<b>Cinema Film 2</b> Rich tone and color typical of a movie theater		<b>Reference</b> Original image without any adjustment	
<b>TV</b> Watching TV programs, sports, concerts, etc.		<b>Photo</b> For still images taken with a digital camera		<b>Game</b> Well-modulated colors and fast response	
<b>Bright Cinema</b> Movies in a bright environment, such as a living room		<b>Bright TV</b> TV programs in a bright environment		<b>User</b>	

## Long-lasting Lamp

The lamp lasts approximately up to 5,000 hours – that's roughly 60% longer than our standard home theater projectors – to lower your costs and total cost of ownership.

## Built-in 3D Sync Transmitter

You can synchronise the projector with the 3D glasses thanks to the 3D synchronous transmitter built into the front of the projector, thus reducing set-up time and removing the need for extra cabling.



Built-in 3D Sync Transmitter

## Whisper-quiet Fan 21dB

The VPL-HW55ES runs very quietly with an advanced air discharge system. Through a highly efficient cooling system, fan noise is suppressed to a mere 21dB. With whisper-quiet fan noise, you can concentrate on a movie or game in a quiet environment without distraction.

## Motionflow

Motionflow technology allows the VPL-HW55ES to display twice as many images per second. This algorithm, unique to Sony, creates completely new images based on the incoming signal, and inserts them between the original frames to reproduce smoother, sharper motion.

## Advanced SXRD Panels

produce an ultra-smooth picture by minimizing the space between pixels at a superfast speed. The VPL-HW55ES is synchronised with our 3D glasses for a jaw-dropping experience and minimal crosstalk.

## Dynamic Lamp Control Technology for 3D

When each of the shutters on the 3D glasses opens, Dynamic Lamp Control Technology automatically boosts the brightness in the image to that eye, maximizing the picture's impact and the lamp's efficiency. This means that you will not lose any brightness, but instead attain an optimal visual experience from the comfort of your own home.

## Separate 2D and 3D Modes

The VPL-HW55ES allows you to pre-select separate parameters for 2D and 3D content under a variety of application modes – Dynamic, Standard, Game, Cinema and Photo – as well as automatically recognising 2D or 3D input.

## Panel Alignment Function

The VPL-HW55ES is configured with a function that compensates for gaps in character or color management. It is possible to select R (Red) or B (Blue) to make adjustments based on G (Green), and to adjust the horizontal and vertical direction by shifting the full image or selecting zones for each color.

## RCP (Real Color Processing) Version 2

The VPL-HW55ES offers an RCP (Real Color Processing) function to adjust the color and hue of each target color of the projected picture independently. Additionally, version 2 adds the ability to adjust the brightness at the same time. With this capability, you can tweak the images to perfection.

## Specifications

Display System	SXRD panel, projection system	
Display device	Size of effective display area	0.61" x 3
	Number of pixels	6,220,800 (1920 x 1080 x 3) pixels
Projection lens	Focus	Manual
	Zoom	Manual (Approx. x1.6)
	Lens shift	Manual, Vertical: +/- 71%, Horizontal: +/- 25%
	Throw Ratio	1.39:1 to 2.11:1
Light source	High-pressure mercury lamp, 200 W type	
Recommended lamp replacement time*1	5000 H (Lamp mode: Low)	
Filter replacement cycle (Max.)	Same time as the lamp replacement is recommended	
Screen size	40" to 300" (1,016 mm to 7,624 mm)	
Light output	1700 lm (Lamp mode: High)*2	
Color light output	1700 lm (Lamp mode: High)*2	
Contrast ratio	120,000:1 (Dynamic Contrast)	
Displayable scanning frequency	Horizontal	19 kHz to 72 kHz
	Vertical	48 Hz to 92 Hz
Display resolution	Computer signal input	Maximum display resolution: 1920 x 1080 dots (HDMI input only)
	Video signal input	480/60i, 576/50i, 480/60p, 576/50p, 720/60p, 720/50p, 1080/60i, 1080/50i The following items are available for HDMI input only. 1080/60p, 1080/50p, 1080/24p
OSD language	15-languages (English, Dutch, French, Italian, German, Spanish, Portuguese, Russian, Swedish, Norwegian, Japanese, Simplified Chinese, Traditional Chinese, Korean, Thai)	
INPUT OUTPUT (Computer / Video / Control)	HDMI (2 inputs)	HDMI 19-pin (x2)
	Y Pb/Cb Pr/Cr	Pin Jack (x3)
	INPUT A	RGB/Y Pb/Cb Pr/Cr input connector: Mini D-sub 15-pin
	REMOTE	RS-232C, D-sub 9-pin (female)
	IR IN	Mini Jack
	3D Sync	RJ-45
Operating temperature / Operating humidity	5°C to 35°C (41°F to 95°F) / 35% to 85% (no condensation)	
Storage temperature / Storage humidity	-20°C to +60°C (-4°F to +140°F) / 10% to 90% (no condensation)	
Power requirements	AC 100 V to 240 V, 3.0 A to 1.3 A, 50/60 Hz	
Power consumption	AC 100 V to 120 V	Max. 300 W
	AC 220 V to 240 V	Max. 300 W
Standby mode power consumption	AC 100 V to 120 V	8 W / 0.5 W (Standby mode: Standard / Low)
	AC 220 V to 240 V	8 W / 0.5 W (Standby mode: Standard / Low)
Dimensions (W x H x D) (without protrusions)	407.4 x 179.2 x 463.9 mm 16 1/8 x 7 1/8 x 18 3/8 inches	
Mass	Approx. 10 kg / 22 lb 1 oz	
Supplied accessories	RM-PJ23 Remote Commander (1), Size AA (R6) Manganese Batteries (2), AC Power Cord (1), Lens Cap (1), 3D Glasses (2), Pouch for the Glasses (2), Operating Instructions (1), Operating Instructions for the 3D glasses (1)	

\*1 The figures are expected maintenance time and not guaranteed. They will depend on the environment or how the projector is used.  
\*2 The values are estimate.

## Optional Accessories



**LMP-H202**  
Projector Lamp  
(for replacement)



**TDG-PJ1**  
IR 3D Glasses



**TMR-PJ2**  
IR External Transmitter

## Control Panel

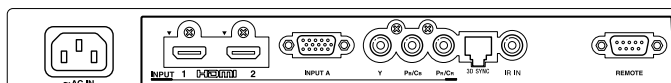

## Dimensions

Units: mm (inches)

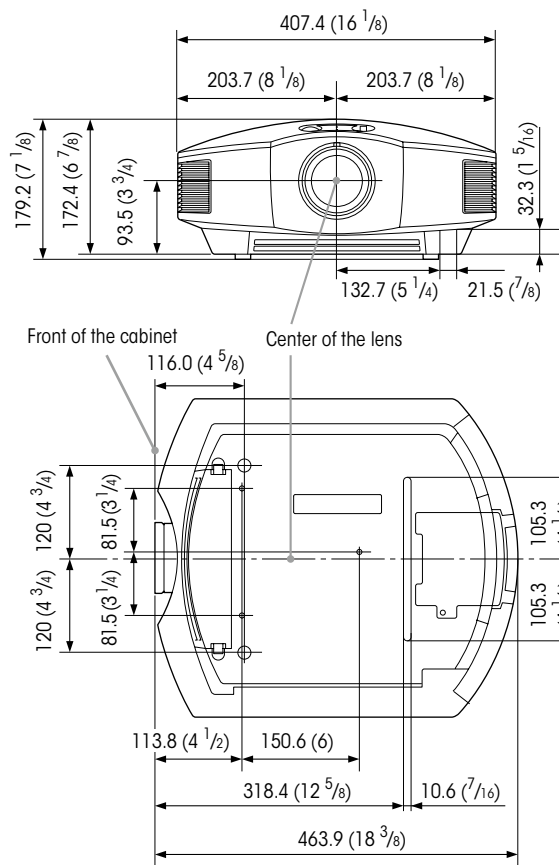

### Distributed by

MK11083V1Y1T13SEP

© 2013 Sony Corporation. All rights reserved.  
 Reproduction in whole or in part without written permission is prohibited.  
 Features and specifications are subject to change without notice.  
 The values for mass and dimension are approximate.  
 "SONY", "make.believe", "SXRD", "Motionflow" and "24p True Cinema" are trademarks of Sony Corporation.  
 The terms HDMI and HDMI High-Definition Multimedia Interface, and the HDMI Logo are trademarks or registered trademarks of HDMI Licensing LLC in the United States and other countries.  
 All other trademarks are the property of their respective owners.