



VPL-S Series

Data Projectors

VPL-SW125

VPL-SX125



BrightEra™

HDMI

Short-throw Projection Minimizes Glare and Shadows Low TCO, Energy Efficient & Easy Operation

Sony's VPL-S Series data projectors are affordable and ideal for a number of different applications, especially in education and business.

The VPL-SW125 offers 2,600 lumens* brightness and wide screen projection with WXGA resolution, while the VPL-SX125 provides 2,500 lumens* brightness and high image quality with XGA resolution.

In addition, both of these models achieve large-screen projection from very short distances – each has a short focal-length lens which overcomes typical problems such as distracting the presenter or obscuring the projected image with shadow. Designed to deliver a low total cost of ownership (TCO), these projectors also include energy efficient features such as a long-lasting lamp design and low power consumption. These features combine with ease of use to make the VPL-S Series ideal for both the classroom and the meeting room.



*ISO 21118

FEATURES

Short Projection Distance

VPL-S Series projectors come equipped with a short focal-length lens, which makes it possible to project images from a short distance. For example, an 80-inch image can be projected from a distance of approximately 3.48 feet and 3.28 feet by the VPL-SW125 and VPL-SX125, respectively. The short projection distance has two key benefits. First, the presenter cannot be distracted by light from the projector, and it's easier for the audience to see the projected image because screen shadow is minimized. Second, sufficient meeting space is secured even in a relatively small room because the projector can be positioned close to the screen.



With conventional models (normal throw)
Caught in intense light, the presenter is temporarily distracted. This is uncomfortable for everyone – the audience can't see the projected image obscured by his shadow.

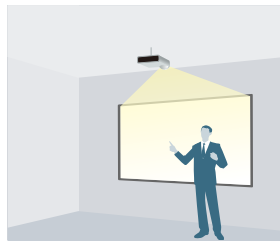

With the VPL-SW125 & VPL-SX125 (short throw)
Virtually all of the light is projected precisely where it should be – onto the screen, not into the presenter's eyes – and the presenter does not block the presentation.



With conventional models (normal throw)
A lot of space is wasted. Here the entire table needs to be clear or the image is partially obscured.

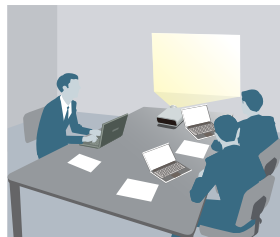

With the VPL-SW125 & VPL-SX125 (short throw)
The entire image is visible now that the projector is positioned closer to the screen.

Cost-efficient, Energy-efficient Design

Long-lasting Lamp

By incorporating a high-performance lamp and advanced lamp-control technology, VPL-S Series projectors deliver an extremely long lamp replacement time of 6,000 hours.*¹

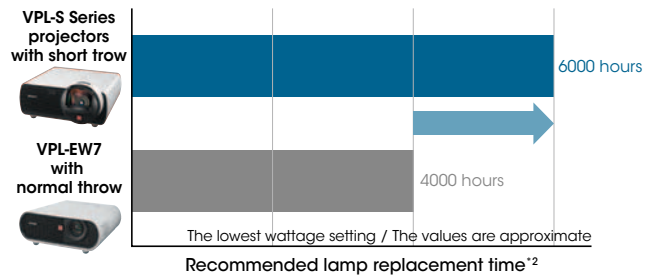

*1 Expected maintenance times, not guaranteed. Lamp & filter performance will vary based on operating environment and use.
*2 Average with lamp dimming.

ECO MODE Key

With a single push of the ECO MODE key on either the projector or the supplied Remote Commander™ unit, users can switch to the ECO setting.

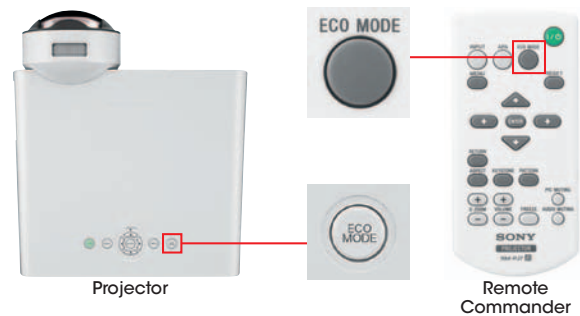

ECO MODE key

ECO setting

| | | | |
|-------------------|----------|----------|---------|
| Lamp Mode | High | Standard | Low |
| Power-saving Mode | Off | Lamp-Off | Standby |
| Standby Mode | Standard | | Low |

ECO MODE menu

Power-saving Mode

If no signal is input for ten minutes, the projector lamp automatically turns off.

Lamp and Filter Synchronized Maintenance

When it's time to clean the air filter, a reminder message is displayed on screen. Like the lamp, the air filter has an approximate 6,000-hour cleaning cycle. The filter only needs to be cleaned when the lamp is changed, saving maintenance effort and cost*.

*Expected maintenance times, not guaranteed. Lamp & filter performance will vary based on operating environment and use.

Low Power Consumption

The VPL-S Series offers remarkably low power consumption, helping users to save on their electricity expenses.

High Picture Quality

3LCD Projection Offers Brilliant Color Performance

The VPL-S Series adopts a 3LCD projection system incorporating three LCD panels. This system enables each projector to present bright and natural images.

High Picture Quality and Bright Images

By combining an advanced generation of inorganic LCD panels that utilize Sony's BrightEra® technology with a 3LCD projection system, the VPL-SW125 and VPL-SX125 offer high picture quality and brightness.

WXGA/XGA Resolution

The VPL-SX125 offers native XGA resolution for high picture quality. XGA resolution of 1024 x 768 contains 60% more pixels compared to SVGA resolution of 800 x 600. As a result, XGA resolution delivers much greater detail and finer images. The VPL-SW125 can present dynamic images in native WXGA resolution on a widescreen. WXGA resolution allows projection in a wider display range compared to SVGA and XGA resolution. More information can be displayed on the screen.

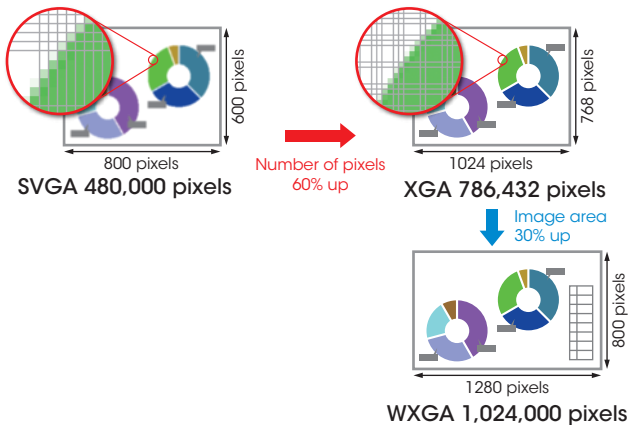

12-bit 3D Gamma Correction

The VPL-S Series incorporates 12-bit 3D gamma correction circuitry to perform highly accurate gamma correction, achieving smoother gradations and a richer gray scale.

CONNECTOR PANELS

VPL-SW125

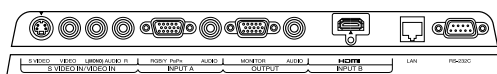

Dynamic Detail Enhancer

Sony's unique video-enhancing technology – Dynamic Detail Enhancer – is incorporated in the VPL-SW125 and VPL-SX125, generating optimized images depending on the type of input signal. There are three settings:

- Off
Plays back interlace format without conversion
- Progressive mode
For interlaced video sources, applies I/P (Interlace/Progressive) signal conversion to project clear and sharp progressive images
- Film mode
When displaying film-originated sources converted by 2-3/2-2 pull-down, accurately reproduces each frame of the original film

HDMI® Interface

The VPL-SW125 is equipped with a High-Definition Multimedia Interface™ (HDMI), which is the latest standard for digitally connecting to high-definition (HD) devices.

Easy-to-use Functions

Image Freeze

The Image Freeze function can display a freeze frame which allows the presenter to prepare or switch to the next image.

Off and Go

After the presentation, the VPL-S Series projector can be immediately moved.

Other Features

Auto Keystone Adjustment

Corrects any trapezoidal distortion automatically

Security Pack

Security lock, security bar, and panel key lock

Direct Power On/Off

Direct power control using the circuit breaker on the switch board

Closed Captioning

Official teletext broadcasting, developed by the NCI, USA

Network and Control

Controls and monitors projector status
Compatible with various control systems



Picture (Audio) Muting

Six Picture Modes

High Altitude Mode

VPL-SX125

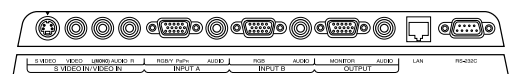

DIMENSIONS

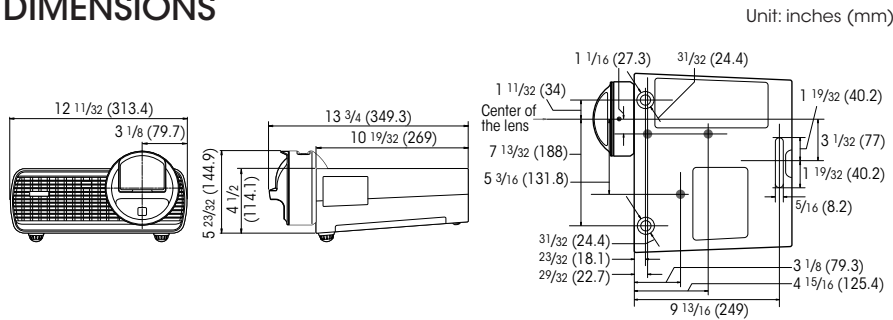

OPTIONAL ACCESSORY



LMP-E211
Projector Lamp (for replacement)

SPECIFICATIONS

| | | VPL-SW125 | VPL-SX125 |
|---|--------------------------------|---|--|
| Display system | | 3 LCD system | |
| Display device | Size of effective display area | 0.59" (15.0 mm) x 3, BrightEra, Aspect ratio: 16:10 | 0.63" (16.0 mm) x 3, BrightEra, Aspect ratio: 4:3 |
| | Number of pixels | 3,072,000 (1280 x 800 x 3) pixels | 2,359,296 (1024 x 768 x 3) pixels |
| Projection lens | Focus | Manual | |
| Light source | | Ultra High Pressure lamp 210 W type | |
| Recommended lamp replacement time*1 | | 3000 H / 4500 H / 6000 H (Lamp mode: High / Standard / Low) | |
| Filter cleaning cycle (replacement) | | Max. 6000 H*1 / Same time as the lamp replacement is recommended | |
| Screen size | | 50" to 100" | 50" to 110" |
| Light output (Lamp mode: High / Standard / Low) | | 2600 lm / 1800 lm / 1400 lm | 2500 lm / 1800 lm / 1400 lm |
| Color light output (Lamp mode: High / Standard / Low) | | 2600 lm / 1800 lm / 1400 lm | 2500 lm / 1800 lm / 1400 lm |
| Contrast ratio (full white / full black)*2 | | 3800:1 | |
| Speaker | | 1 W x 1 (monaural) | |
| Displayable scanning frequency | Horizontal | 19 kHz to 92 kHz | |
| | Vertical | 48 Hz to 92 Hz | |
| Display resolution | Computer signal input | Maximum input signal resolution: 1400 x 1050 (resizing display) Panel display resolution: 1280 x 800 pixels | Maximum input signal resolution: 1400 x 1050 (resizing display) Panel display resolution: 1024 x 768 pixels |
| | Video signal input | NTSC, PAL, SECAM, 480/60i, 576/50i, 480/60p, 576/50p, 720/60p, 720/50p, 1080/60i, 1080/50i | |
| Color system | | NTSC3.58, PAL, SECAM, NTSC4.43, PAL-M, PAL-N, PAL60 | |
| Keystone correction | | Vertical: Max. +/- 15 degrees*3 | |
| OSD language | | 20-languages (English, Dutch, French, Italian, German, Spanish, Portuguese, Turkish, Polish, Russian, Swedish, Norwegian, Japanese, Simplified Chinese, Traditional Chinese, Korean, Thai, Vietnamese, Arabic, Farsi) | |
| Computer and video signal input/output | INPUT A | RGB / Y Pb Pr input connector: Mini D-sub15-pin (female), Audio input connector: Stereo mini jack | |
| | INPUT B | HDMI (HDCP-compatible) | RGB input connector: Mini D-sub 15-pin (female), Audio input connector: Stereo mini jack |
| | VIDEO IN | Video input connector: Pin jack, Audio input connector: Pin jack (x2) (shared with S VIDEO IN) | |
| | S VIDEO IN | S video input connector: Mini DIN 4-pin, Audio input connector: Pin jack (x2) (shared with VIDEO IN) | |
| | OUTPUT | Monitor output connector*4: Mini D-sub 15-pin (female), Audio output connector*5: Stereo mini jack (variable out) | |
| Control signal input/output | | RS-232C connector: D-sub 9-pin (female), LAN connector: RJ45, 10BASE-T/100BASE-TX | |
| Operating temperature (Operating humidity) | | 32°F to 104°F / 0°C to 40°C (20% to 80%; no condensation) | |
| Storage temperature (Storage humidity) | | 14°F to 140°F / -10°C to 60°C (20% to 80%; no condensation) | |
| Power requirements | | AC 100 V to 240 V, 3.0 A to 1.3 A, 50 Hz / 60 Hz | |
| Power consumption | AC 100 V to 120 V | 290 W / 240 W / 205 W | |
| | AC 220 V to 240 V | 275 W / 225 W / 190 W | |
| Standby mode power consumption | AC 100 V to 120 V | 3 W / <1.0 W (Standby mode: Standard / Low) | |
| | AC 220 V to 240 V | 3 W / <1.0 W (Standby mode: Standard / Low) | |
| Heat dissipation | AC 100 V to 120 V | 990 BTU | |
| | AC 220 V to 240 V | 940 BTU | |
| Outside dimensions | | W 12 11/32 x H 5 23/32 x D 13 3/4 in (W 313.4 x H 144.9 x D 349.3 mm) (without protrusion) | |
| Weight | | 8 lb 3 oz (3.7 kg) | |
| Supplied accessories | | RM-PJ7 Remote Commander (1), Lithium battery: CR2025 (1), Mini D-sub 15-pin cable (1), Operating Instructions (CD-ROM) (1), Quick Reference Manual (1), AC Power Cord (1) | |

*1 Expected maintenance times, not guaranteed. Lamp & filter performance will vary based on operating environment and use. *2 Average with lamp dimming. *3 Depends on resolution. *4 From Input A and Input B for VPL-SX125, from Input A only for VPL-SW125. *5 Works as an audio switcher function. Output from a selected channel, not available in standby.

© 2011 Sony Corporation. All rights reserved.
 Reproduction in whole or in part without written permission is prohibited.
 Features and specifications are subject to change without notice.
 Sony, the Sony logo, make.believe logo, BrightEra, and Remote Commander are trademarks of Sony Corporation.
 PjLink is a trademark applied for trademark rights in Japan, the United States of America, and other countries and areas.
 HDMI, the HDMI logo, and High-Definition Multimedia Interface are trademarks or registered trademarks of HDMI Licensing LLC.
 All other trademarks are the property of their respective owners.